

FIITJEE PROGRESS MONITORING TEST (FPMT-3)

ANSWER KEY(Code-113625) Applicable for CPA Batches (A-Lot)

PHYSICS		CHEMISTRY		MATHEMATICS	
1.	C	1.	D	1.	C
2.	B	2.	B	2.	B
3.	C	3.	C	3.	D
4.	C	4.	C	4.	B
5.	D	5.	D	5.	B
6.	B	6.	B	6.	B
7.	A	7.	C	7.	A
8.	C	8.	C	8.	A
9.	D	9.	D	9.	A
10.	C	10.	B	10.	A
11.	A	11.	D	11.	C
12.	A	12.	A	12.	A
13.	A	13.	B	13.	B
14.	B	14.	D	14.	B
15.	B	15.	C	15.	A
16.	B	16.	D	16.	C
17.	C	17.	A	17.	C
18.	B	18.	D	18.	B
19.	B	19.	D	19.	B
20.	A	20.	C	20.	A
21.	B	21.	D	21.	C
22.	B	22.	B	22.	A
23.	C	23.	C	23.	A
24.	B	24.	B	24.	D
25.	B	25.	A	25.	C
26.	C	26.	A	26.	C
27.	A	27.	B	27.	C
28.	C	28.	A	28.	A
29.	B	29.	C	29.	D
30.	A	30.	A	30.	D

HINTS OR SOLUTION

Chemistry

1.

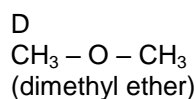

2.

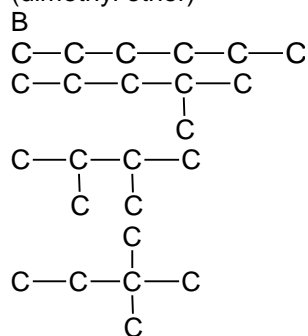

3.

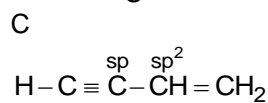

4.

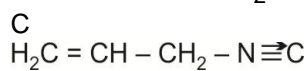

5.

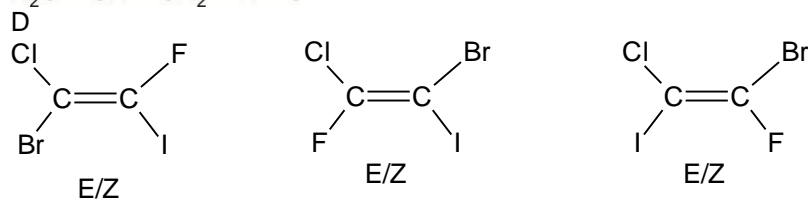

6.

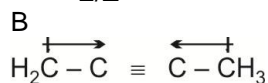

7.

C

10.

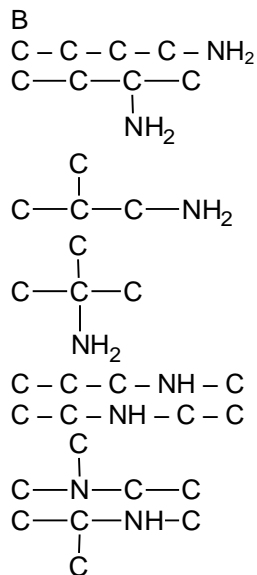

13.

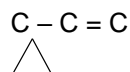

16.

